

41-01-001 , Central Door Locking , Central door locking without central control module

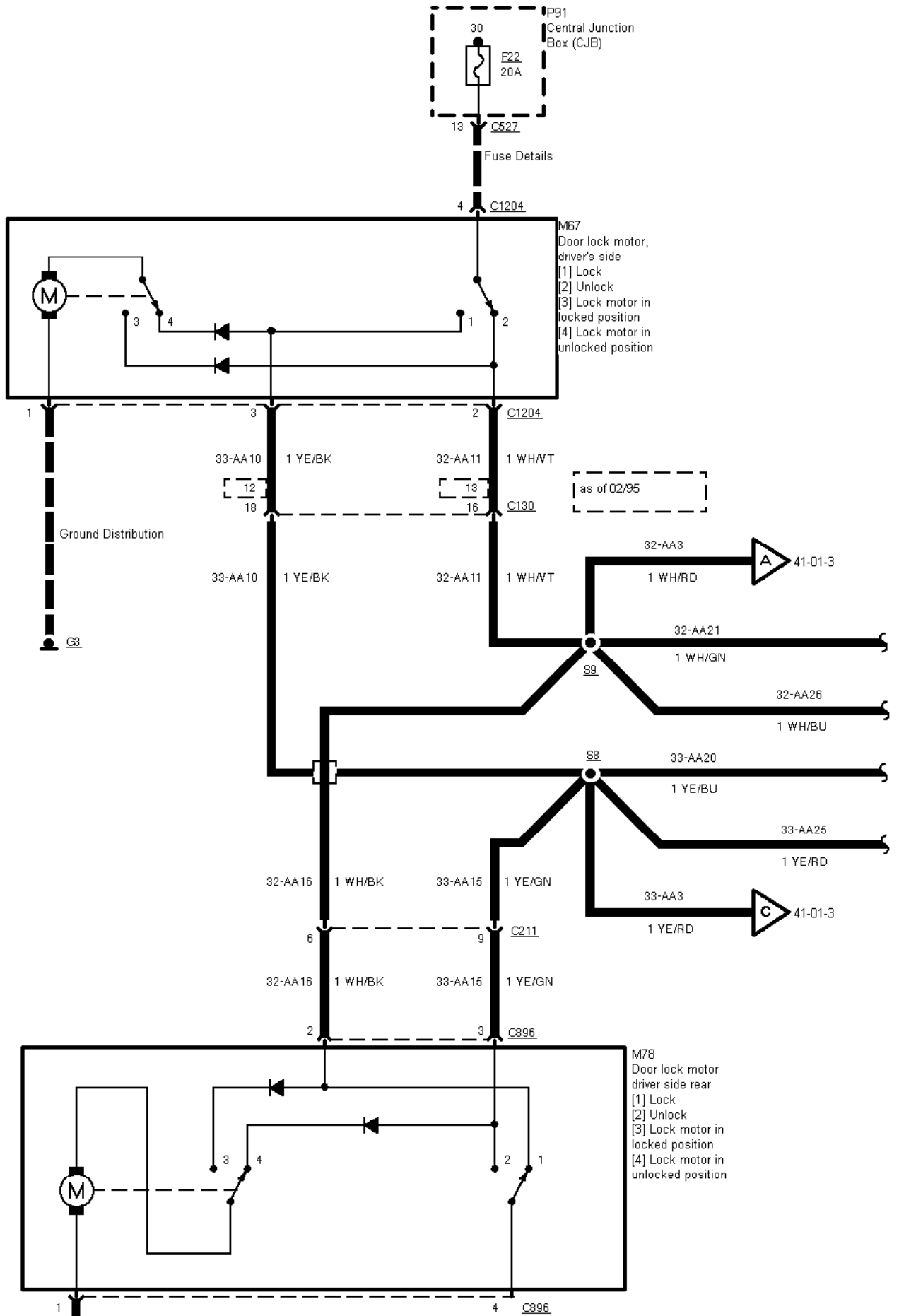

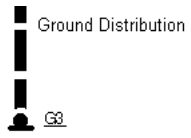
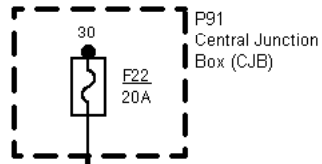

not used

41-01-002 , Central Door Locking , Central door locking without central control module



13 C627
Fuse Details

4 C897

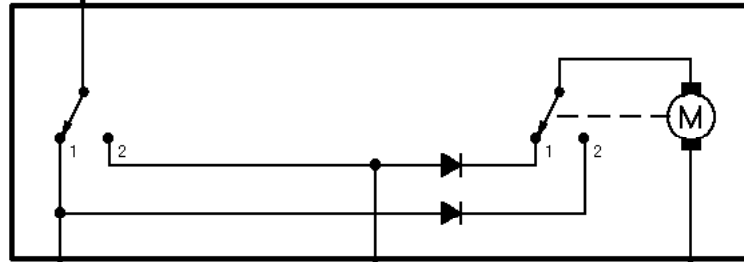

M68
Door lock motor,
passenger's side
[1] Lock
[2] Unlock
[3] Lock motor in
locked position
[4] Lock motor in
unlocked position

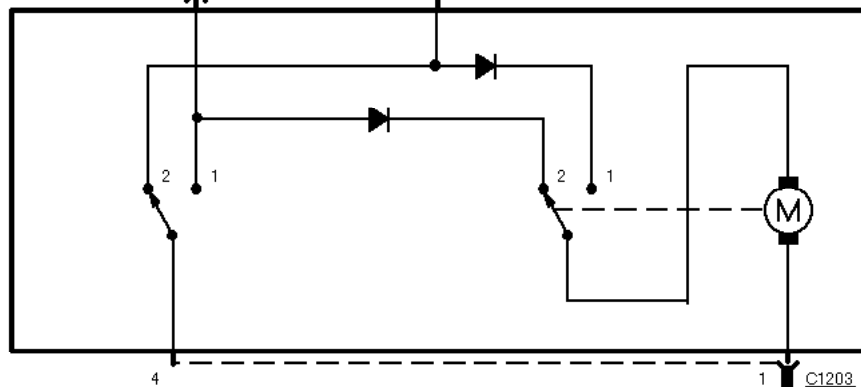
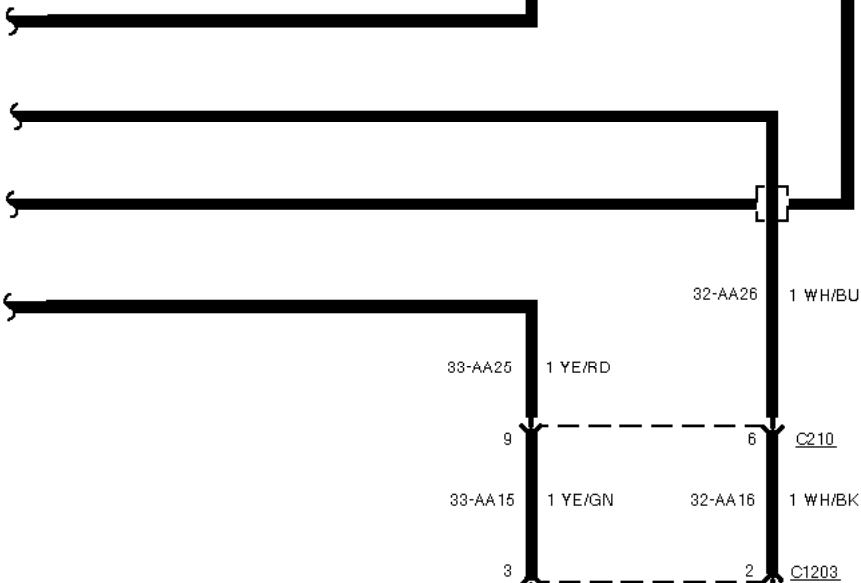
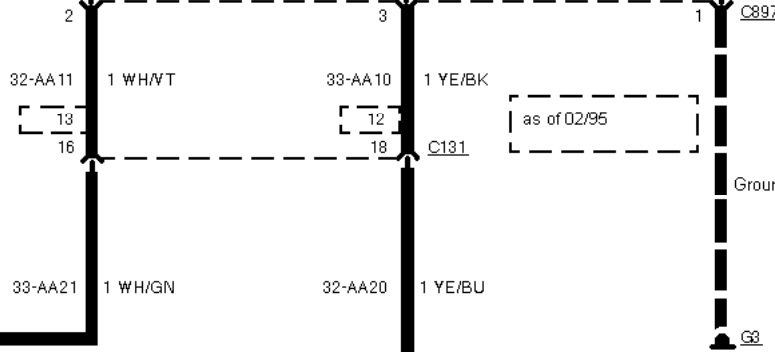

M77
Door lock motor
passenger side rear
[1] Lock
[2] Unlock
[3] Lock motor in
locked position
[4] Lock motor in
unlocked position

4 1 C1203

not used

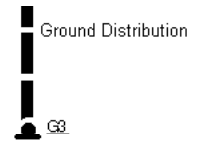

41-01-003 , Central Door Locking , Central door locking without central control module

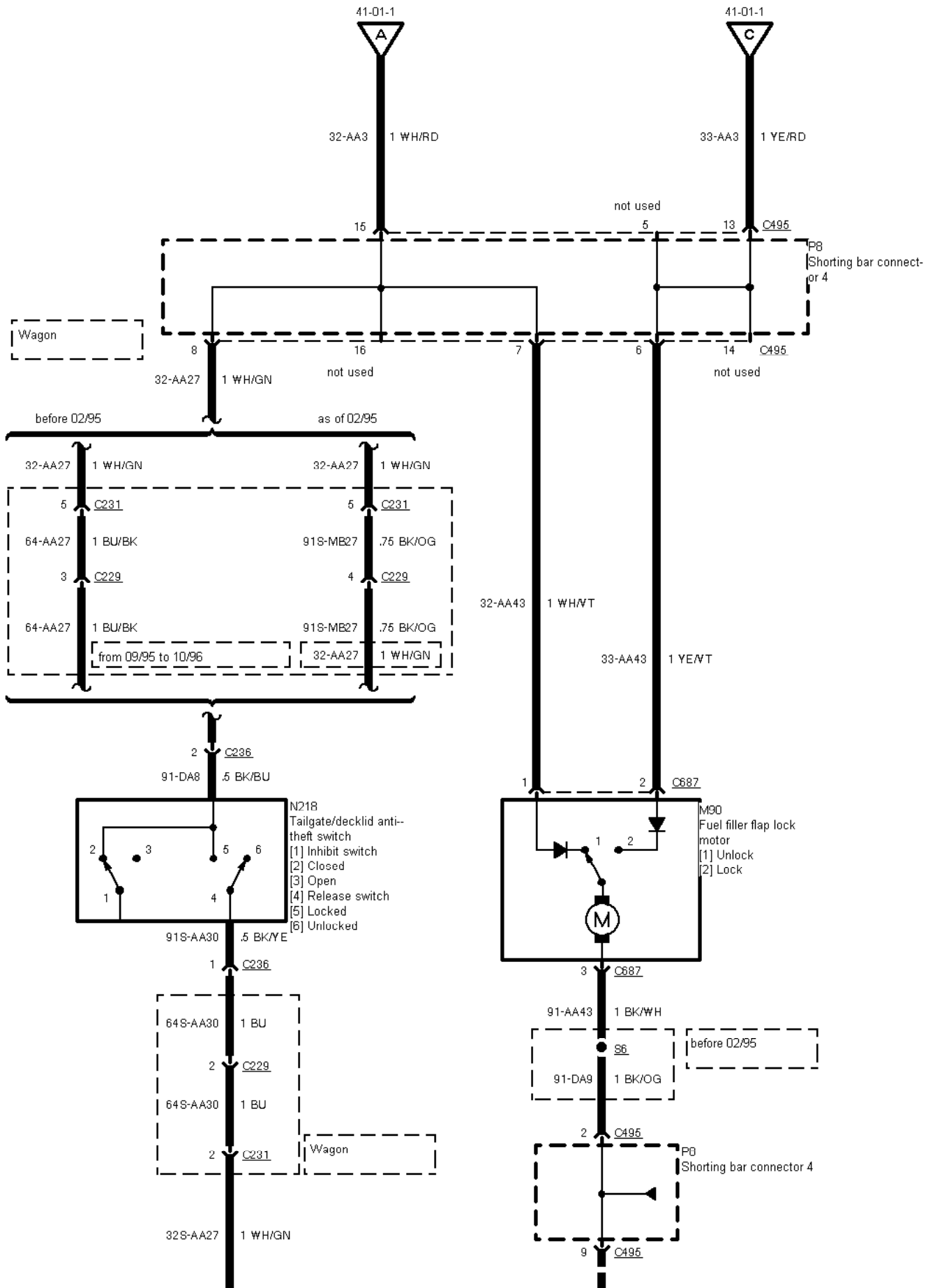



41-01-4

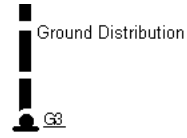

41-01-004 , Central Door Locking , Central door locking without central control module

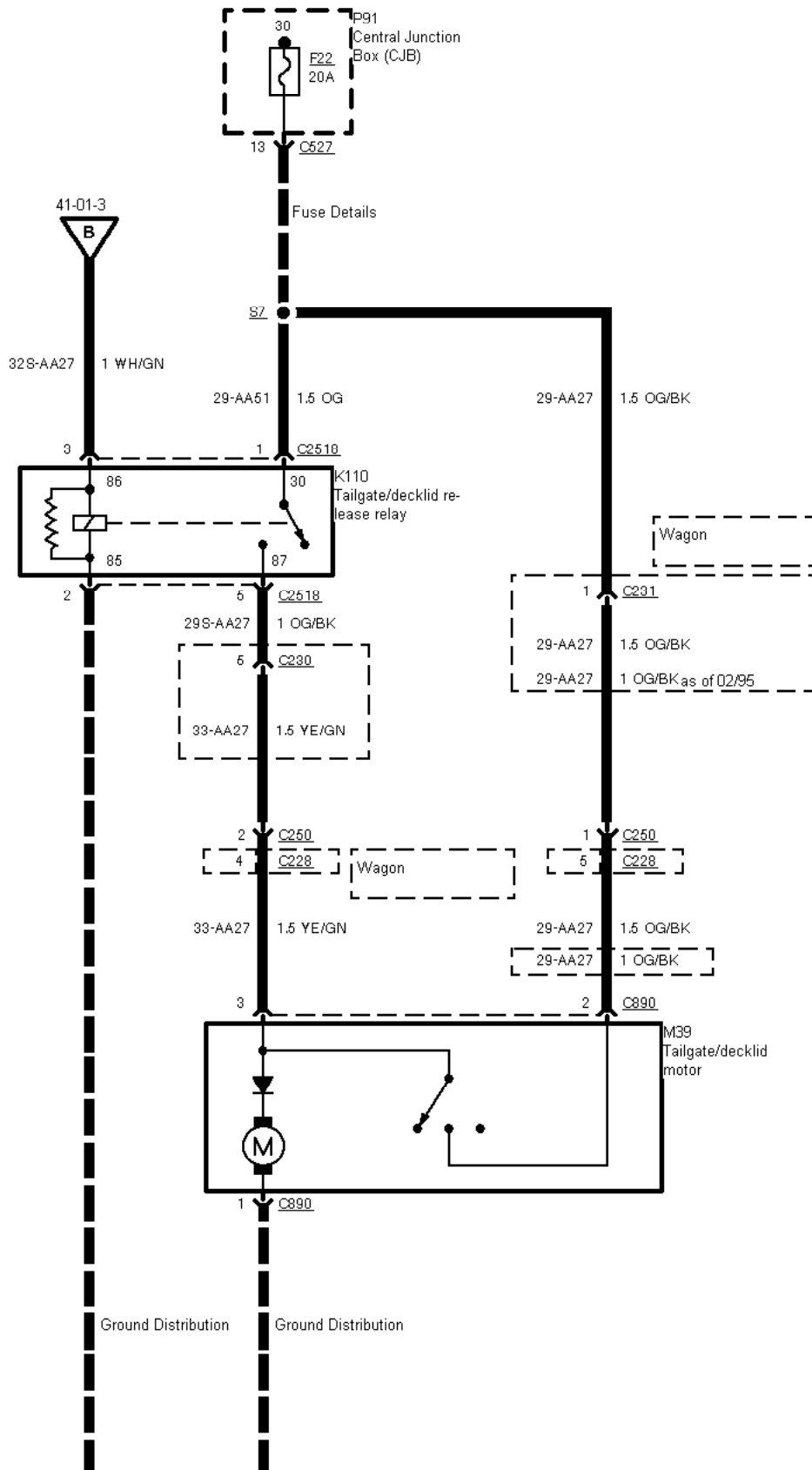



 G1

 G1

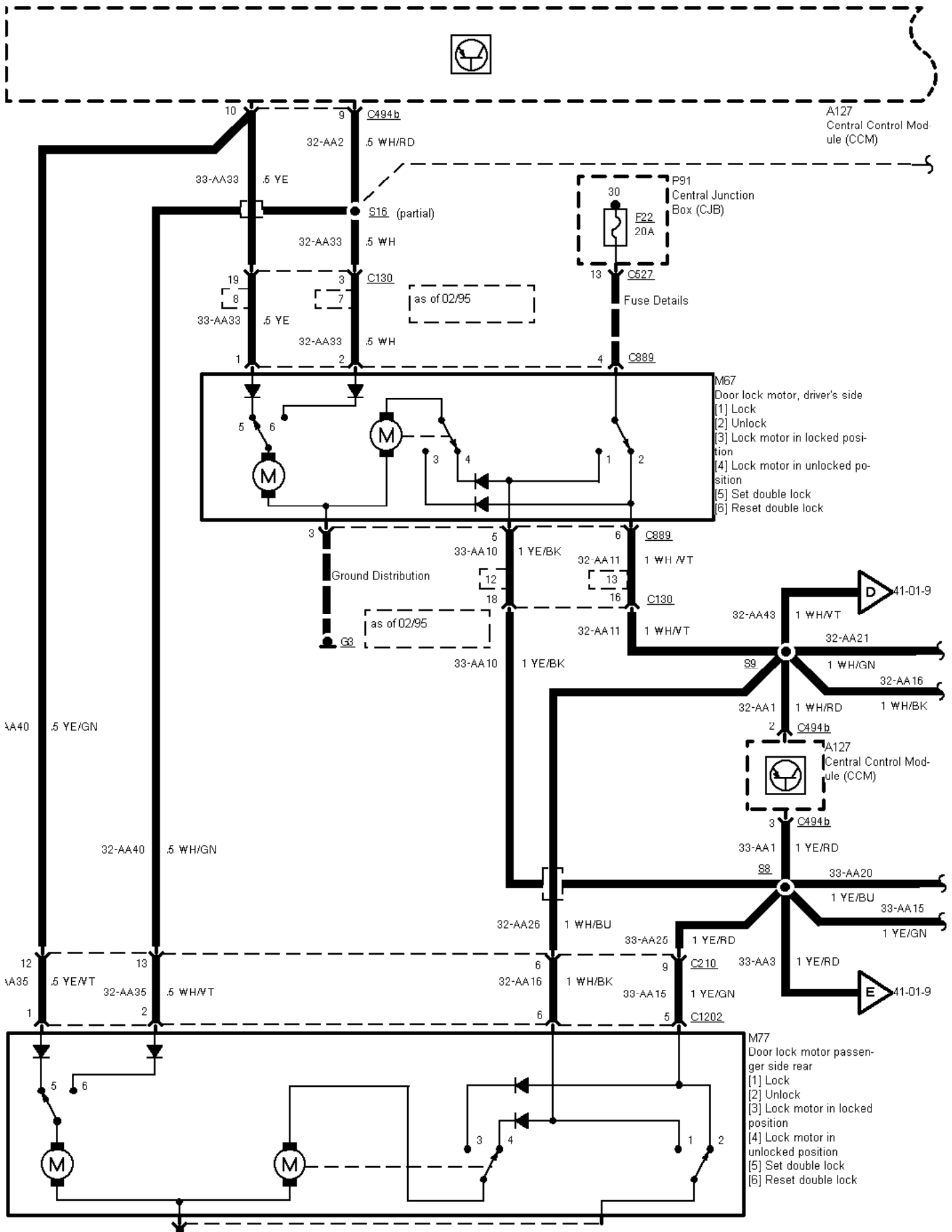
41-01-005 , Central Door Locking , With double locking



3  Ground Distribution
 G3

4 G12U2
not used

41-01-006 , Central Door Locking , With double locking

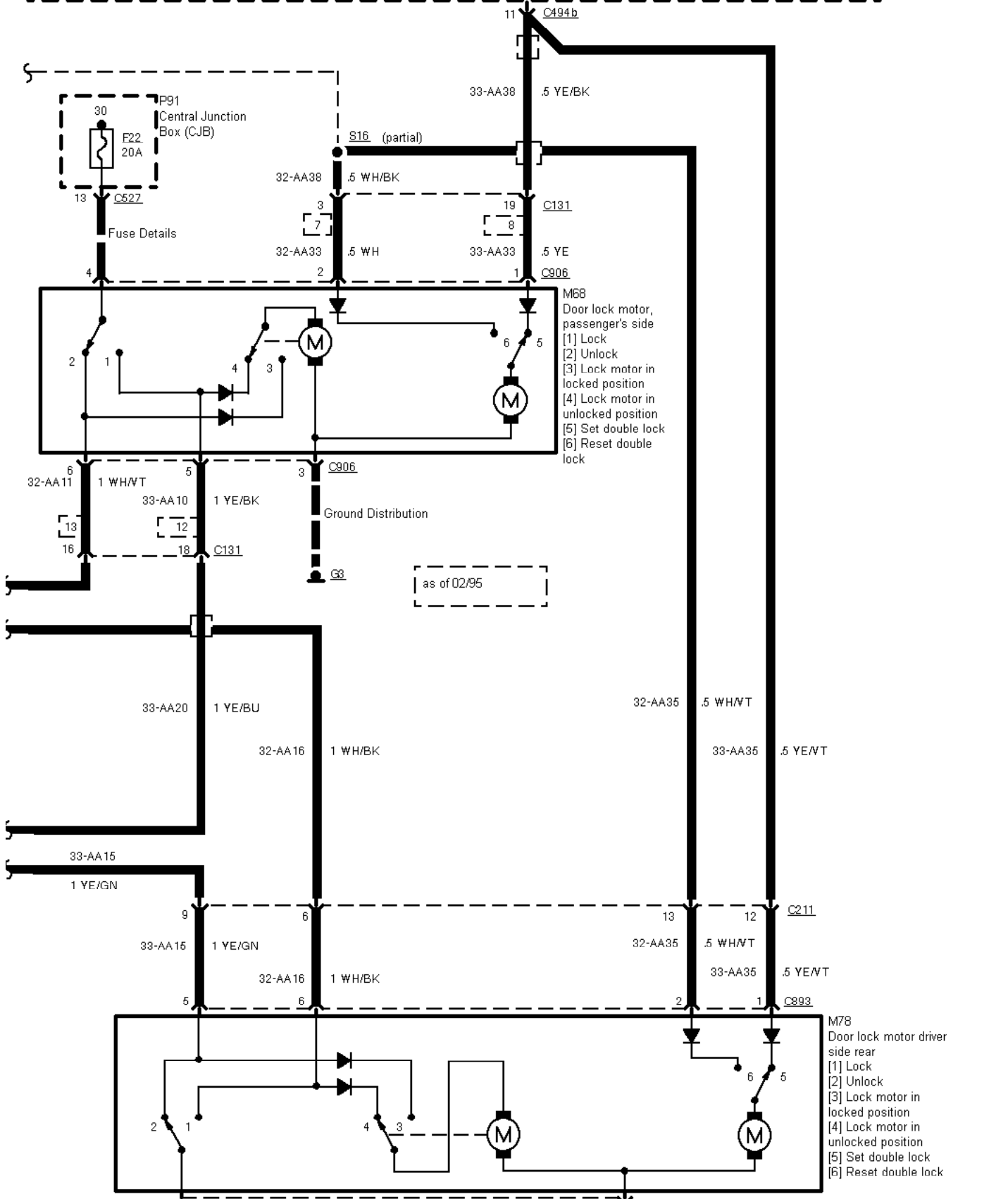

4
not used

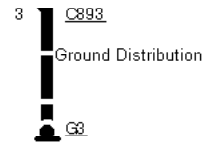

41-01-007 , Central Door Locking , With double locking

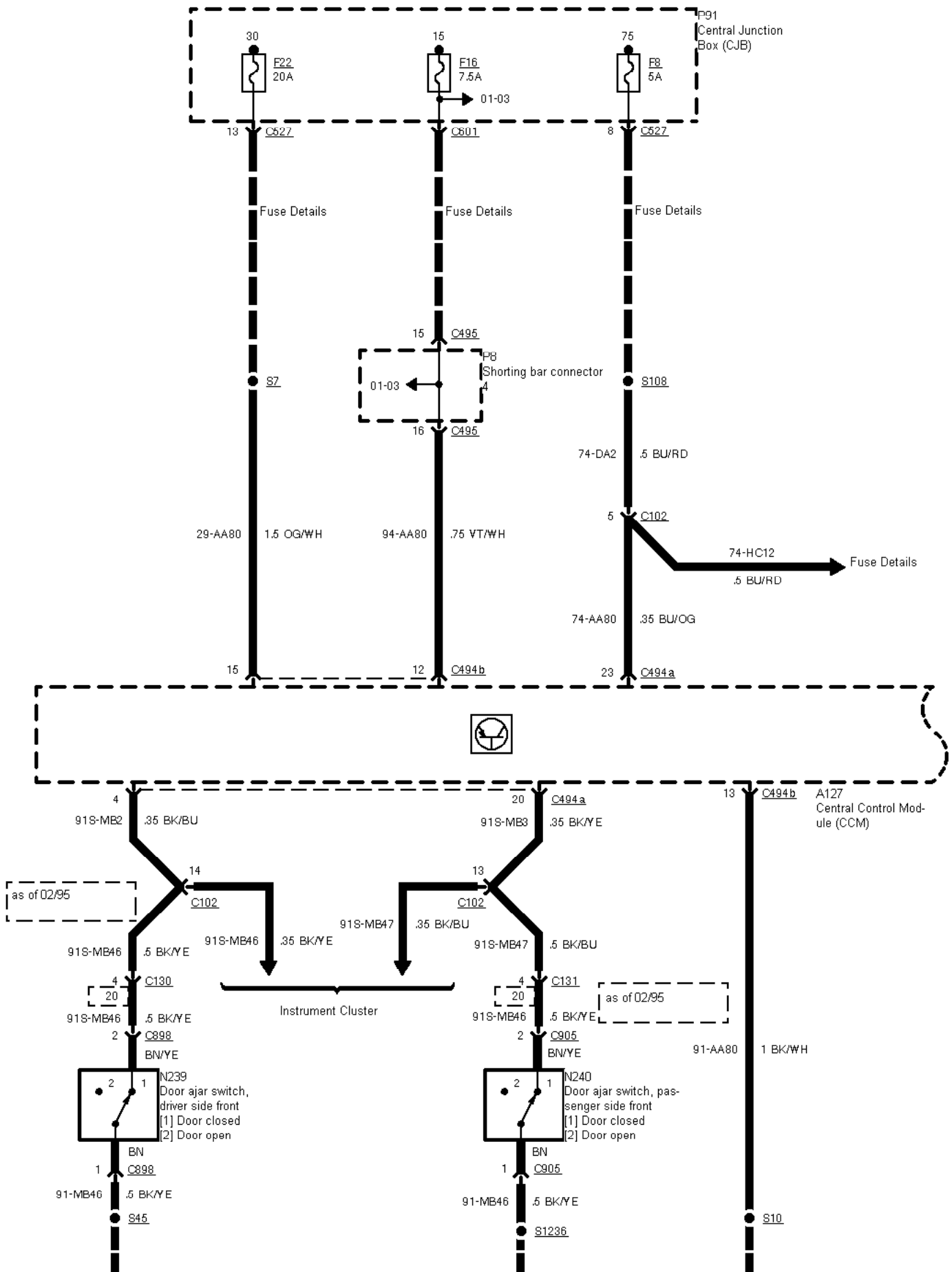

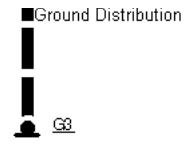
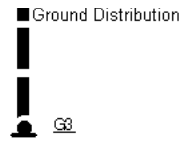
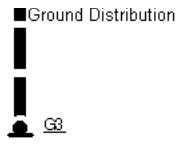

41-01-008 , Central Door Locking , With double locking

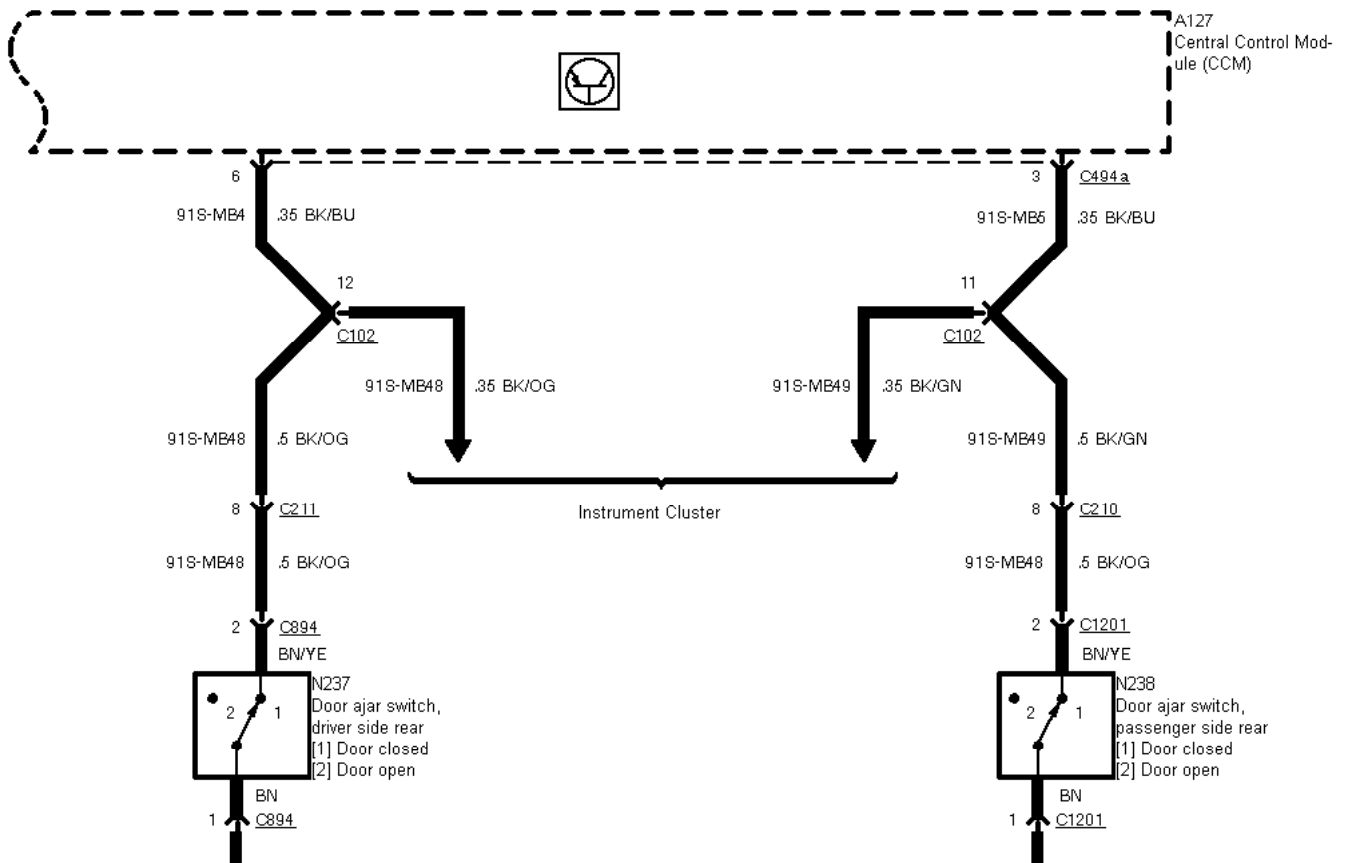
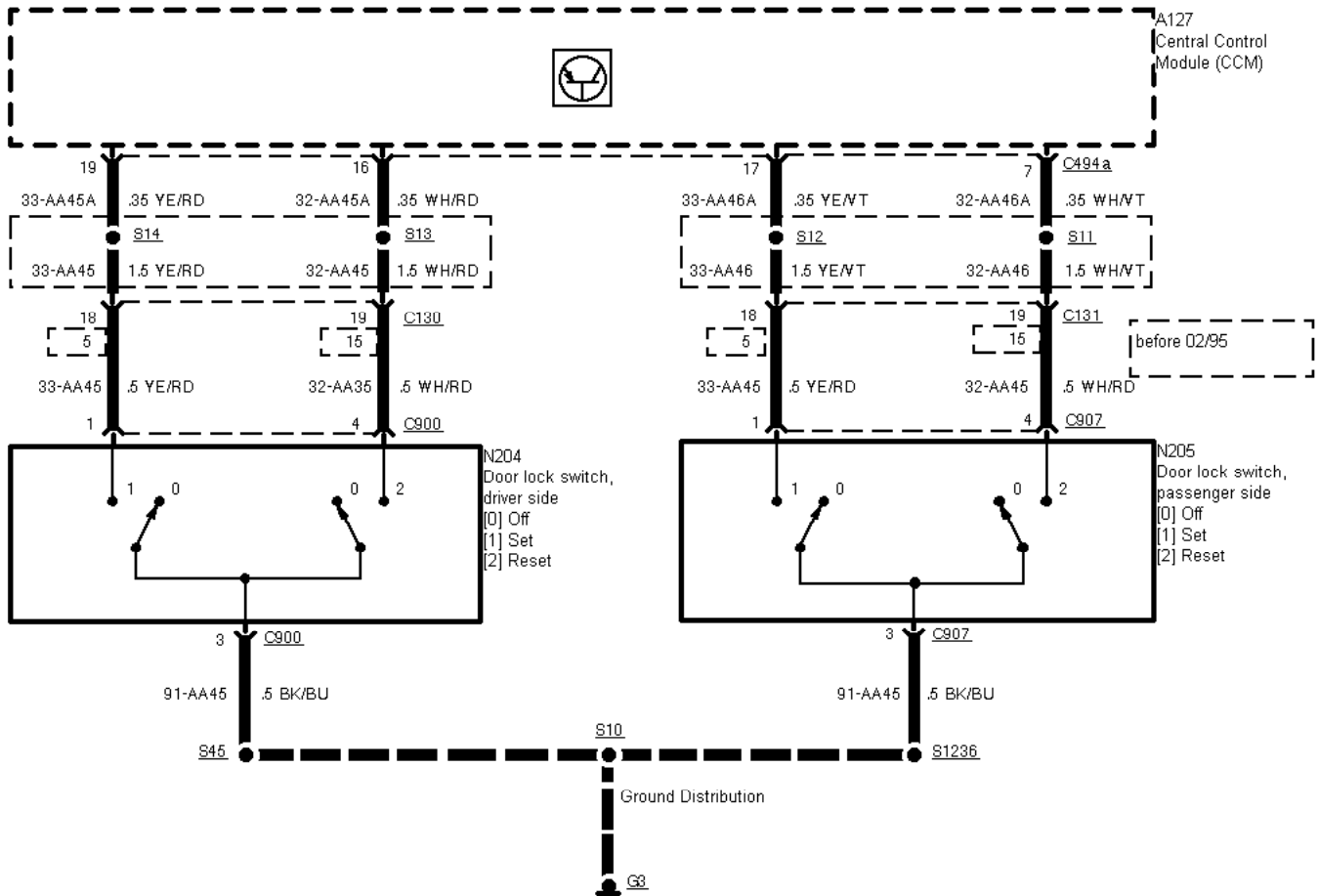

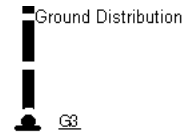
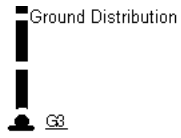

41-01-009 , Central Door Locking , With double locking

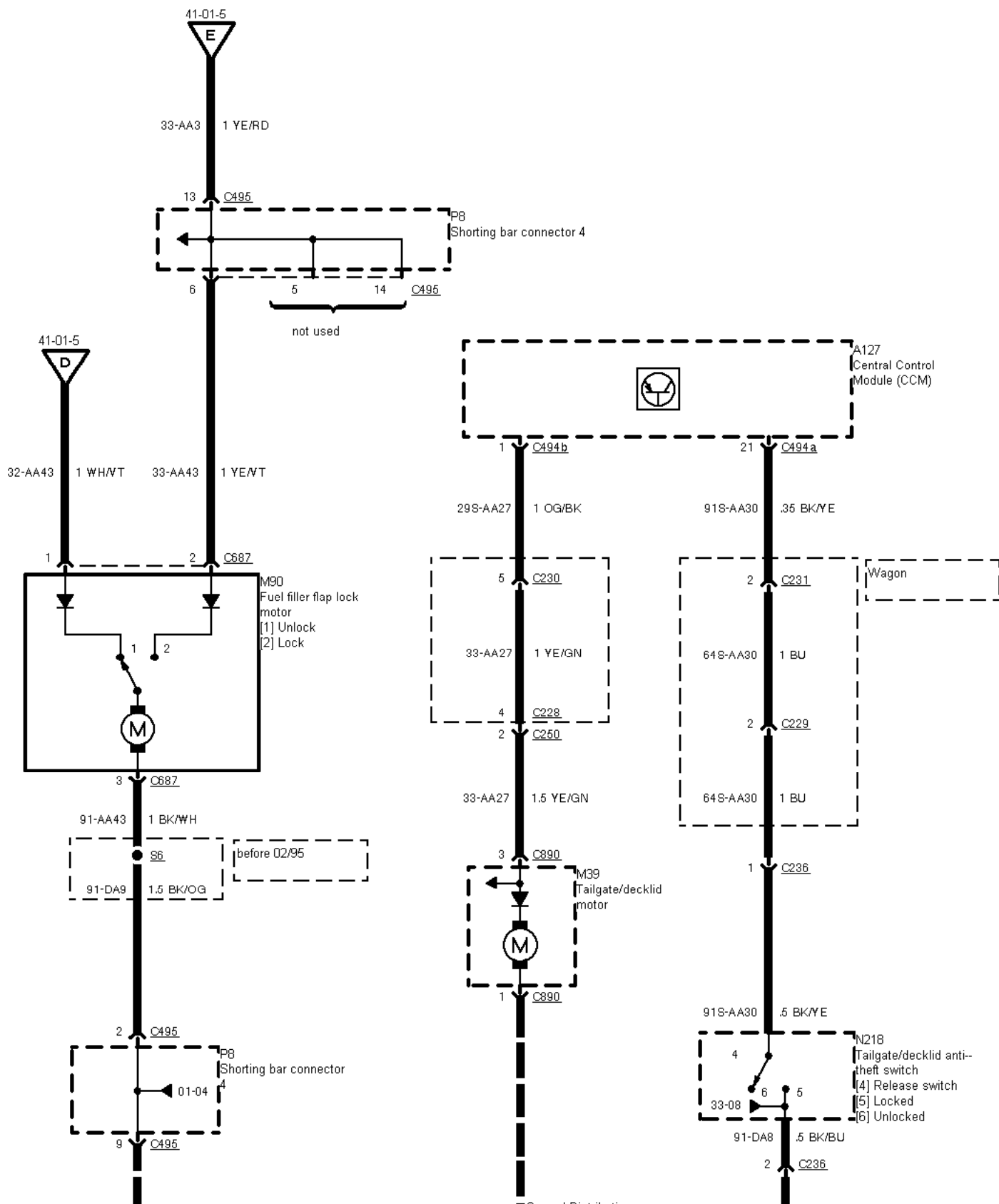

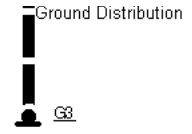
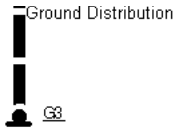

41-01-010 , Central Door Locking , With double locking

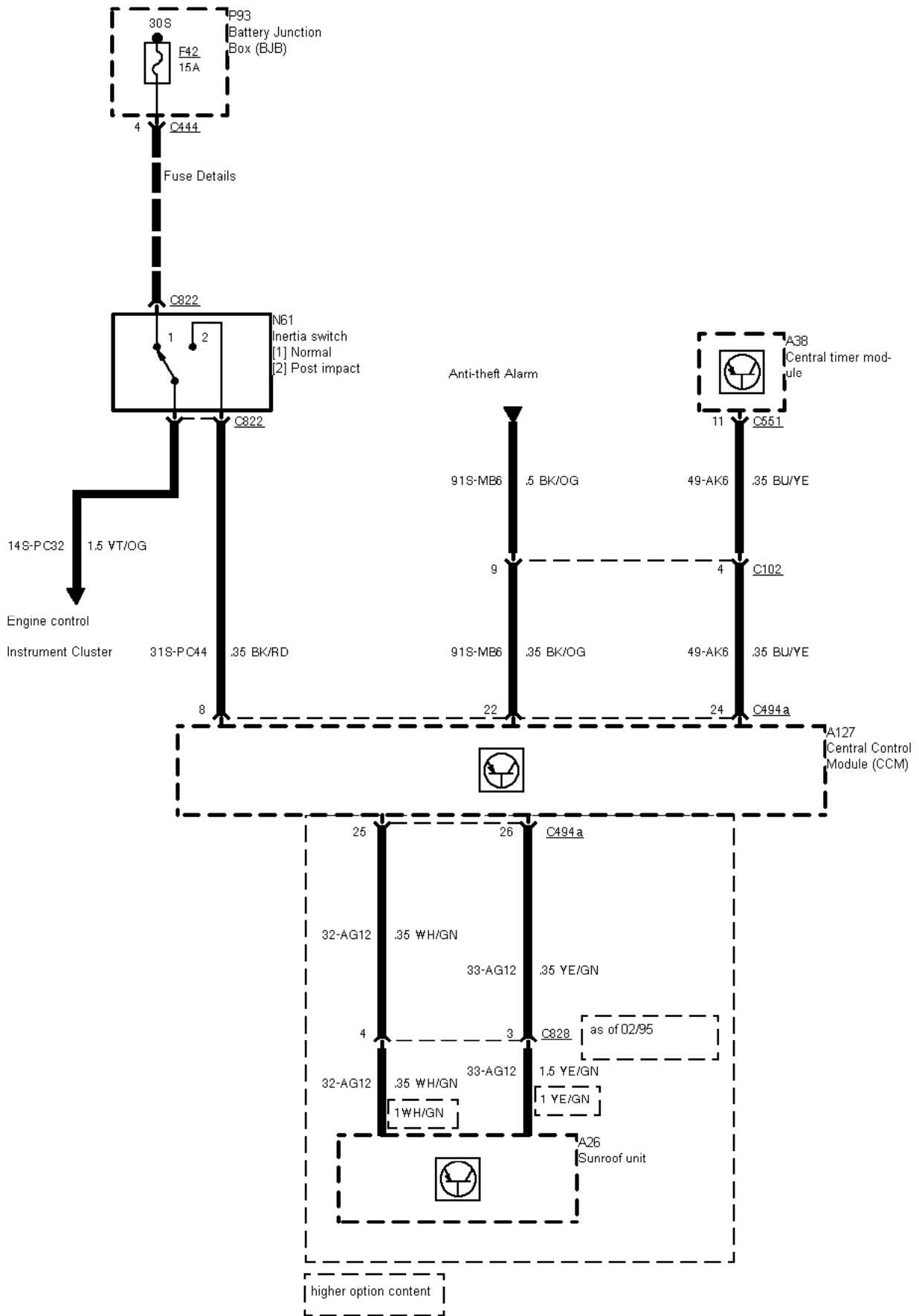

41-01-011 , Central Door Locking

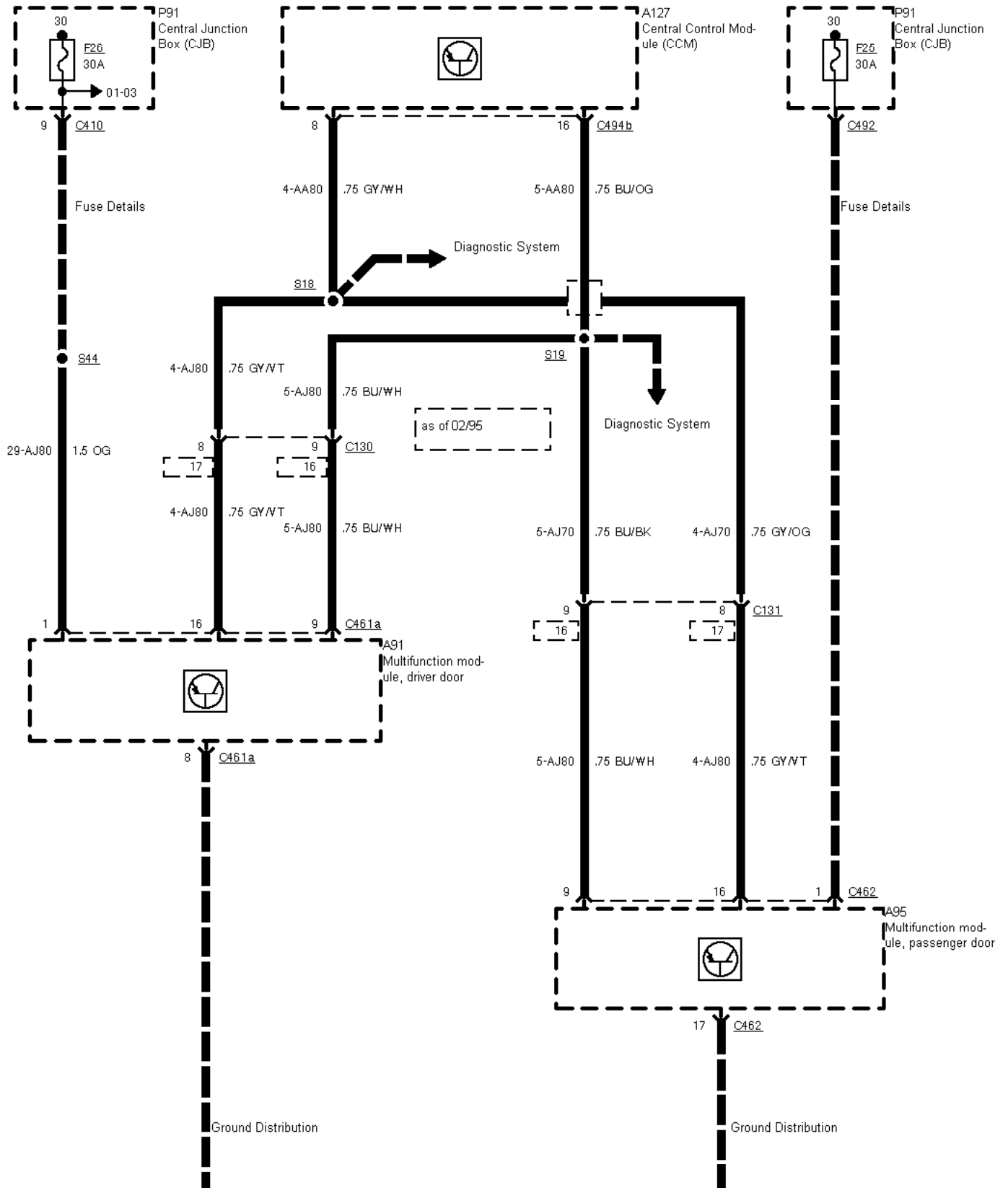

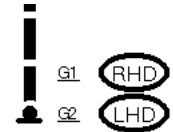

41-01-012 , Central Door Locking , With remote control

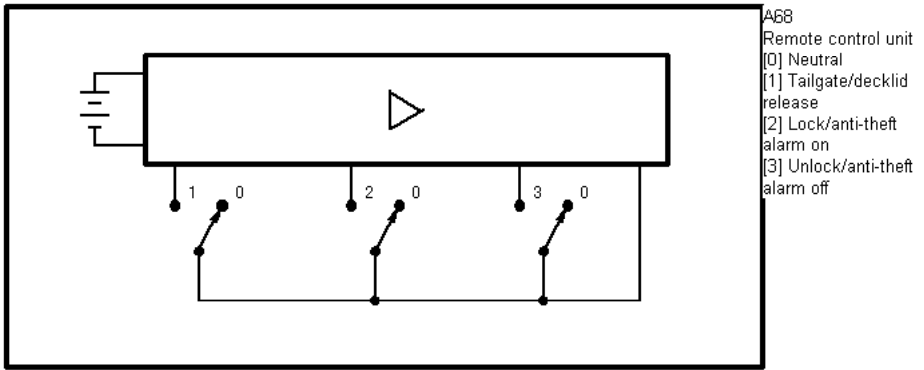
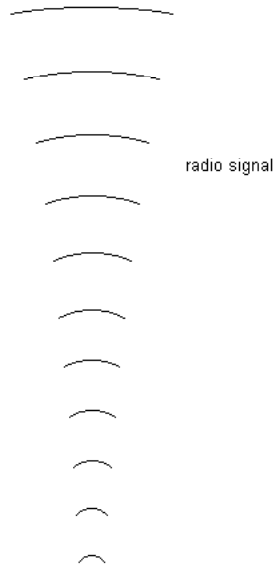
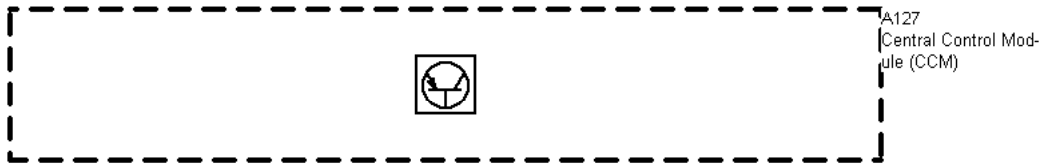

2 Circuit Description
